

THE BRANDON™ TRAX GLASS-LIFTER

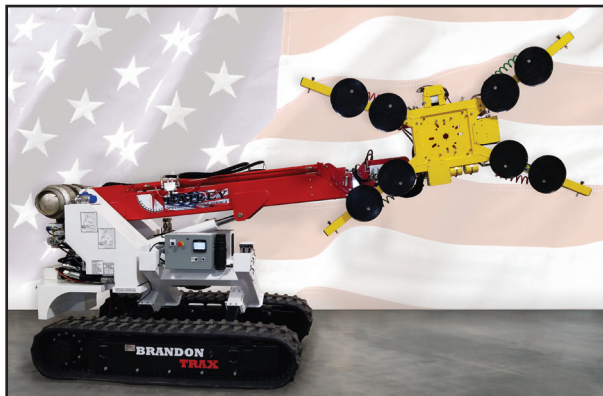

Proactive Safety features

- Warning you of potential problems
- User friendly command prompts
- Continually Monitors Lifting Operations
- Maximizes productivity
- Reduces human error

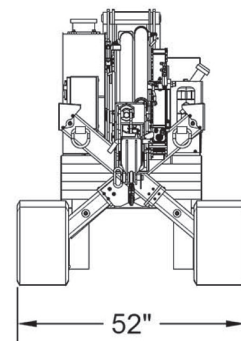
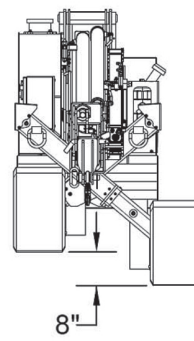
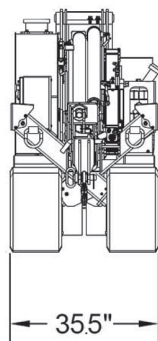
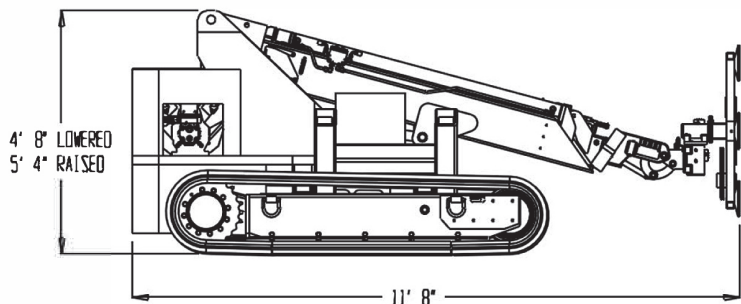

Track Drive for Turf and Rough Terrain Operation

Features

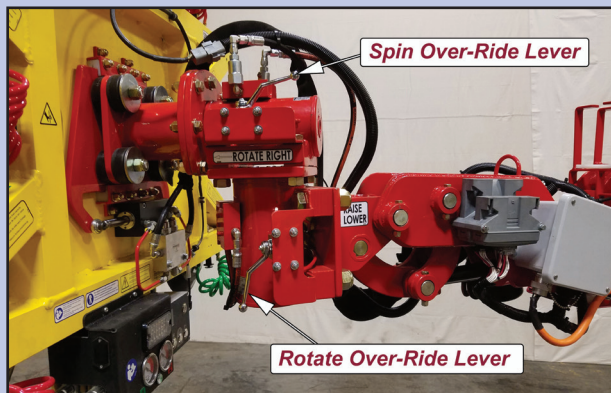

Manual over-ride for quick, precise adjustments

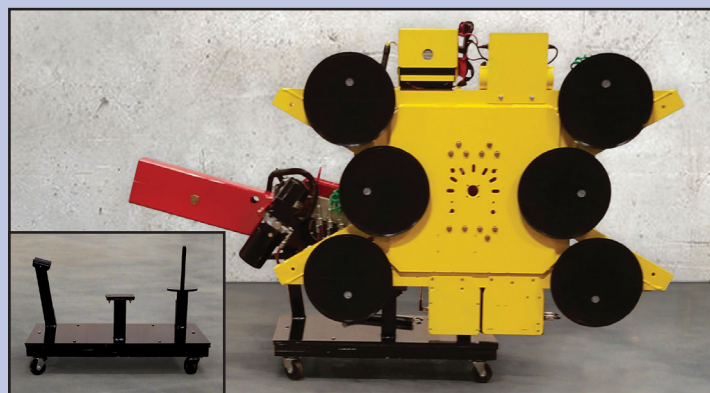

Tip assembly unloads on cart for tight access maneuvering

Frame Configurations and Capacities

